

Flush Mount PIR Motion Sensor

624759 Sensor PIR RC HYT ON/OFF HIR28/H IoT

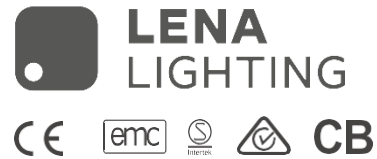

Applications

Office, classroom and commercial interior spaces where ON/OFF control is required.

- Office/Commercial Lighting
- Classrooms
- Stairwells / Corridors



HIR28/H











HIR28 with on/off relay control

Designed with a low profile for aesthetically demanding architectural projects providing a high quality sensor for simple ON/OFF occupancy control or providing semi-automatic (absence detection) control.

An intelligent photocell is also included to prevent switching of the lights when natural daylight is available.

Set-up of the sensor is carried out using a remote control handset with program memory allowing one-key commissioning where common settings are used for multiple devices.

Features

-  Store settings in the remote for easy commissioning when programming multiple sensors
-  Intelligent photocell - lights and sensors only operate when needed, natural light has priority
-  Zero crossing detection to reduce in-rush current and maximise relay life
-  Max withstandable in-rush current: 120A@160µs Black
-  & White & Gray metal surface mount box option Two
-  types of blind inserts / blanking plates
-  User-friendly design for installation
-  High bay version available (up to 21m in height)
-  5 Year Warranty

Technical Data

Input Characteristics	
Mains voltage	220~240VAC 50/60Hz
Stand-by power	< 1 W
Load ratings:	400VA (Capacitive) 800W (Resistive)
Max withstandable in-rush current	120A@160μs
Warming-up	20s

Safety and EMC	
EMC standard (EMC)	EN55015, EN61000
Safety standard (LVD)	EN60669-1, EN60669-2-1
Certification	Semko, CB, CE, EMC, LVD, RCM

Sensor Data	
Sensor Model	PIR detection
Detection range (Max.)* HIR28/H	Installation height : 15m (forklift) 12m (person) Detection range (∅) : 24m
Detection angle	360°

* For more details of detection range, please refer to "detection pattern" section.

Environment	
Operation temperature	Ta: -20°C ~ +50°C
IP rating	IP20

Mechanical Structure

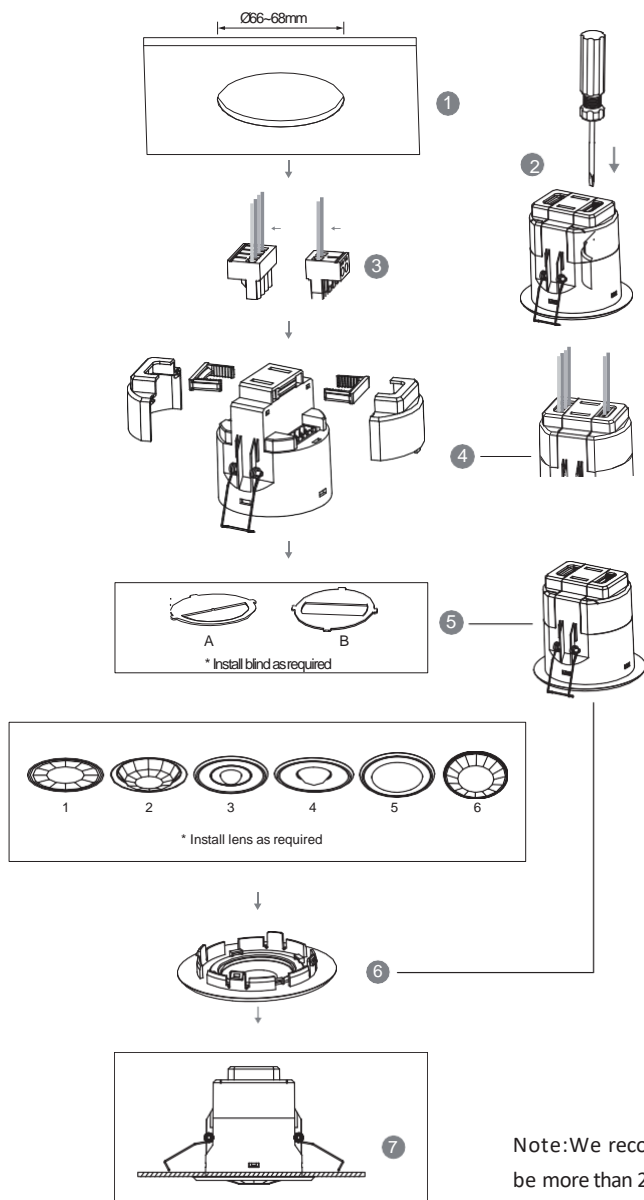

1. Ceiling (drill hole \varnothing 66~68mm)
2. Carefully prise off the cable clamps.
3. Make connections to the pluggable terminal blocks.
4. Insert plug connectors and secure using the provided cable clamps, then clip terminal covers to the base.
5. Fit detection blind (if required) and desired lens.
6. Clip fascia to body (this step is not applicable for /UH).
7. Bend back springs and insert into ceiling.

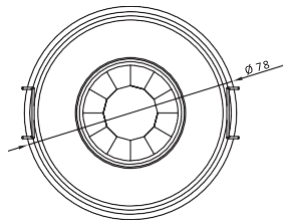

Note: We recommend the mounting distance between sensor to sensor should be more than 2m to prevent sensors from false-triggering.

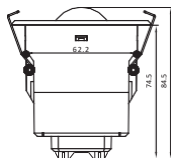

HIR28/H

Wire Preparation

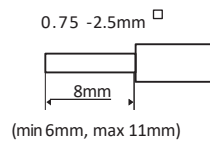

Pluggable screw terminal. It is recommended to make connections to the terminal before fitting to the sensor.

Wiring Diagram

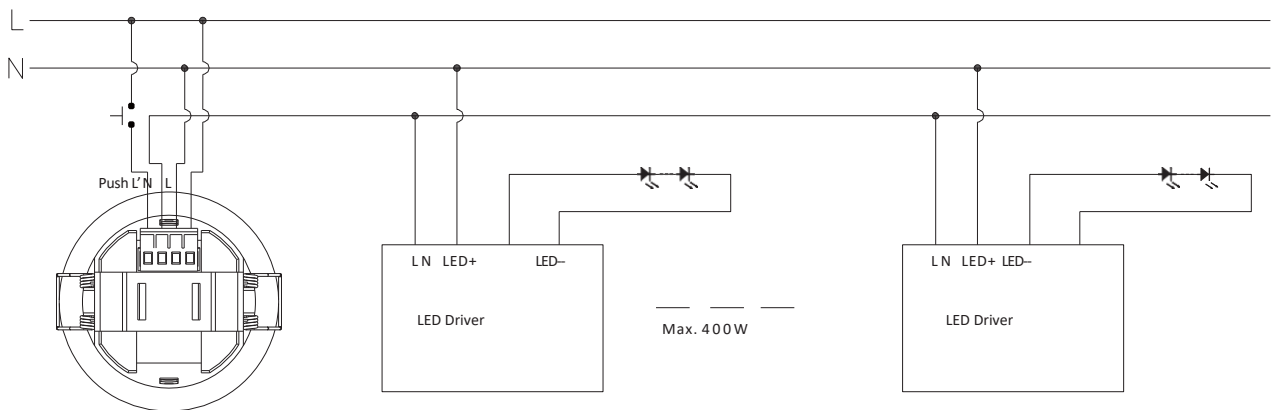

4. HIR28/H (High-bay)

HIR28/H: High-bay lens detection pattern for **forklift** @ Ta = 20°C

(Recommended ceiling mount installation height **10m-15m**)



A: Tangential movement

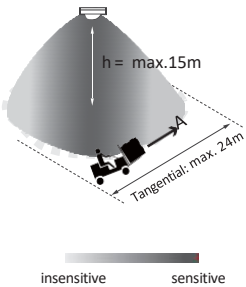

B: Radial movement

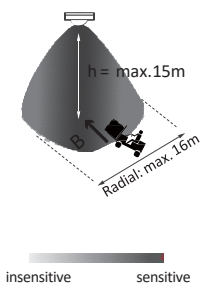

Mount height	Tangential (A)	Radial (B)
10m	max 380m ² (∅ = 22m)	max 201m ² (∅ = 16m)
11m	max 452m ² (∅ = 24m)	max 201m ² (∅ = 16m)
12m	max 452m ² (∅ = 24m)	max 201m ² (∅ = 16m)
13m	max 452m ² (∅ = 24m)	max 177m ² (∅ = 15m)
14m	max 452m ² (∅ = 24m)	max 133m ² (∅ = 13m)
15m	max 452m ² (∅ = 24m)	max 113m ² (∅ = 12m)

HIR28/H: High-bay lens detection pattern for **single person** @ Ta = 20°C

(Recommended ceiling mount installation height **2.5m-12m**)



A: Tangential movement

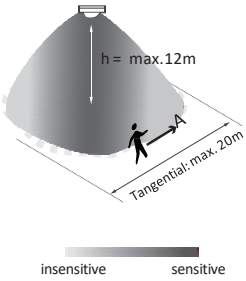

B: Radial movement

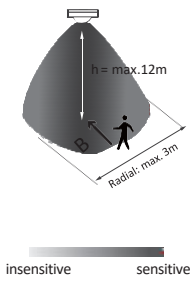

Mount height	Tangential (A)	Radial (B)
2.5m	max 50m ² (∅ = 8m)	max 7m ² (∅ = 3m)
6m	max 104m ² (∅ = 11.5m)	max 7m ² (∅ = 3m)
8m	max 154m ² (∅ = 14m)	max 7m ² (∅ = 3m)
10m	max 227m ² (∅ = 17m)	max 7m ² (∅ = 3m)
11m	max 269m ² (∅ = 18.5m)	max 7m ² (∅ = 3m)
12m	max 314m ² (∅ = 20m)	max 7m ² (∅ = 3m)

Optional Accessory –Ceiling/Surface Metal Mount Box: HA09/W, HA09/B, HA09/G

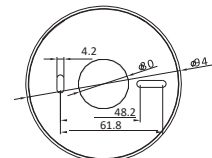
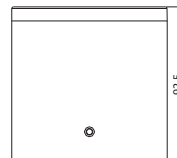

Optional Accessory –Blind Insert for Blocking Certain Detection Angles

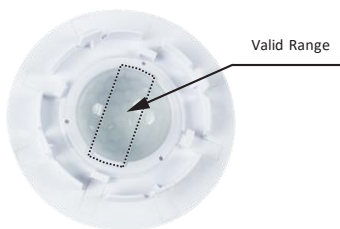

Blind Option 1 --- Aisle Detection

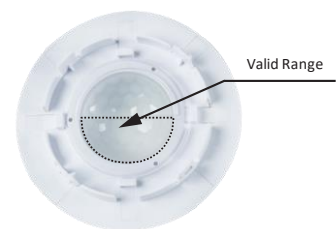

Blind Option 2 --- 180° Detection

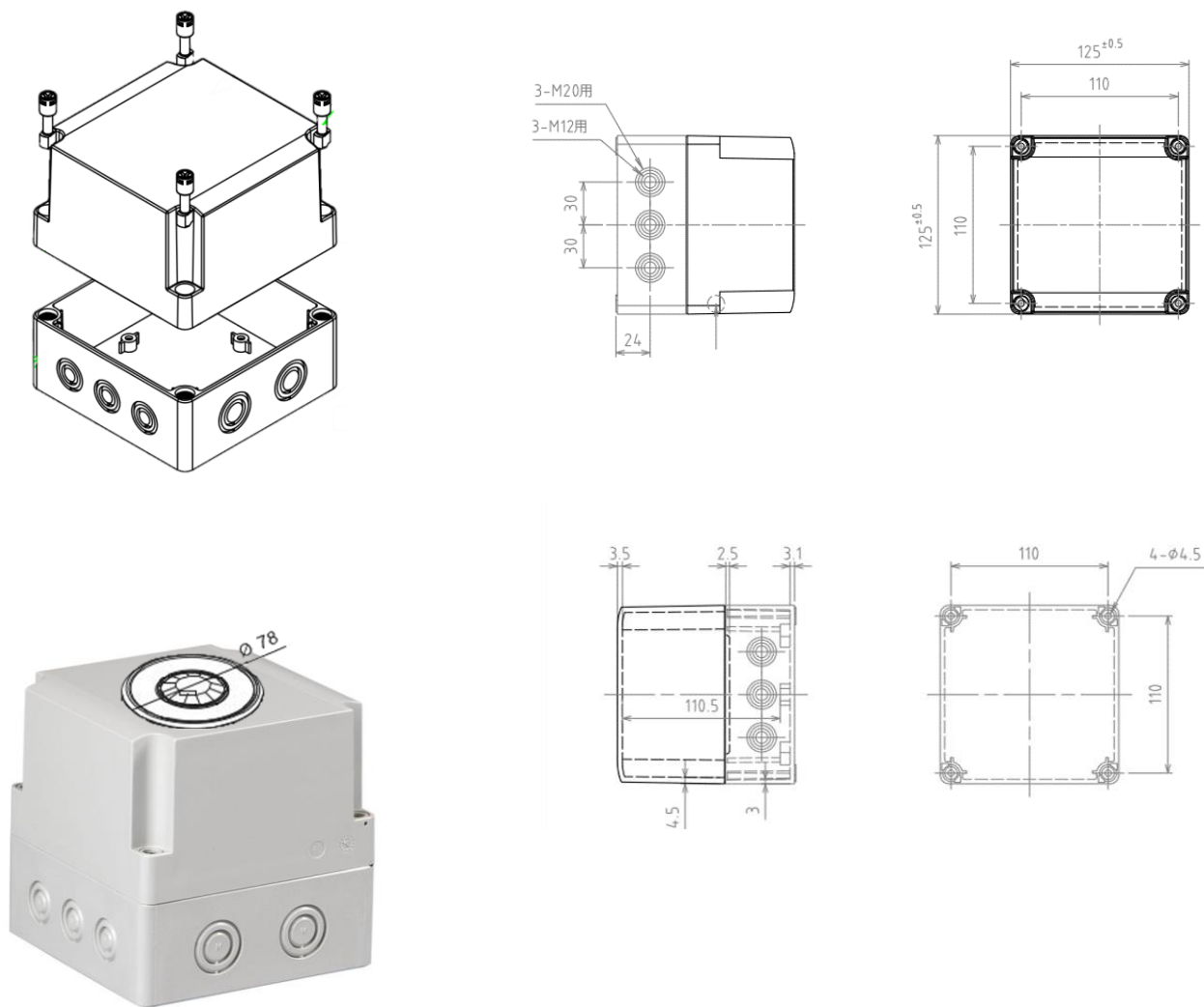

Manufac turer's code	Dimensions			Internal dimensions			Can color	Weight [g]
	S	W	G	s	w	g		
SPCM13 1313G	125	125	125	114.5	110.5	90	RAL7035	401

1 On/off Control

This sensor is a motion switch, which turns on the light upon detection of motion, and turns off after a pre-selected hold-time when there is no movement. A daylight sensor is also built in to prevent the light from switching on when there is sufficient natural light.

2 Intelligent Photocell (daylight detection prior to motion detection)

The built-in photocell will also automatically turn off the light when the ambient natural light exceeds the programmed lux level for more than 5min, regardless of whether motion is detected or not.



With sufficient natural light, the light does not switch on when presence is detected.



With insufficient natural light, the sensor switches on the light automatically when presence is detected.

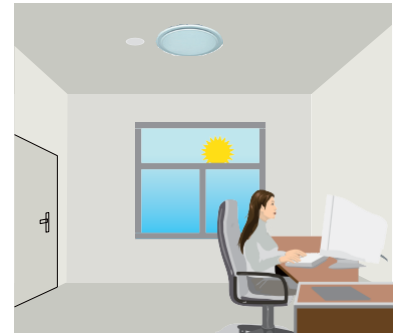

The sensor switches off the light when natural light is sufficient, even with presence.

3 Manual Override

With the help of push-switch, this sensor can be over-riden by the end-user to manually switch on/off the light, which makes the product more user-friendly and offers more options to fit some extra-ordinary demands:

* Short Push (<1s): on/off function;

On → Off: the light turns off immediately and cannot be triggered ON by motion until the expiration of pre-set hold-time. After this period, the sensor goes back to normal sensor mode.

Off → On: the light turns on and goes to sensor mode, no matter if ambient Lux level exceeds the daylight threshold or not.

Note: if end-user do not want this manual override function, just leave the "push" terminal unconnected to any wire.

4 Semi-auto Mode (Absence Detection)

It is easy to forget to switch off the light, in office, corridor, even at home. And in many other cases, people do not want to have a sensor to switch on the light automatically, for example, when people just quickly pass-by, there is no need to have the light on. The solution is to apply this "absence detector": motion sensor is employed, but only activated on the manual press of the push-switch, the light keeps being ON in the presence, and switches off in the long absence.

Note: end-user can choose either function 3 or function 4 for application. Default function is manual override.

5 Zero-cross Relay Operation

Designed in the software, sensor switches on/off the load right at the zero-cross point, to ensure that the in-rush current is minimised, enabling the maximum lifetime of the relay.

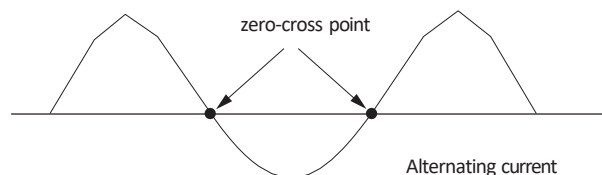

For more information, contact iot@lenalighting.pl